

IKS9 Incremental Magnetic Sensing Head

The incremental sensing head IKS9 from BOGEN delivers reliable results in all industrial areas where positions, distances and speeds have to be measured. IKS9 features an accuracy of better than 10 μm , a travel speed of up to 100 m per second, an almost unlimited measuring length and a robust design. Numerous adjustable parameters allow the customer to easily adapt the IKS9 to application-specific needs. IP67 protection class allows use even in harsh environments. In combination with an appropriate scale - linear, rotary-radial or rotary-axial - a highly accurate, reliable and fast acquisition of measurement data is possible.

Incremental
Measuring

Rotary
Linear
Applications

Positioning



Features and Benefits

- high accuracy better than 10 μm
- resolution up to 20 nm
- movement speed up to 100 m/sec
- easy to adapt to application-specific needs
- resistant to contamination, vibrations, temperature, fluctuations, humidity

Features

resolution	0.02 - 1250 μm (depending on pole pitch)
max. movement speed	up to 100 m/s (depending on pole pitch, resolution and maximum output frequency)
energy consumption (without load)	< 65 mA ($U_B = 5\text{ V}$)
operating temperature	- 20 to + 70 °C
storage temperature	- 20 to + 80 °C
protection class	IP67
LED⁽¹⁾	green LED: set up ok red LED: error mode see order codes page 6
adjustable parameters⁽²⁾	resolution/interpolation interface length of reference pulse frequency LED mode hysteresis counting direction
weight	without cable and connector IKS9: 6,5 g IKS9.1: 17,5 g cable: drag chain quality (T2): approx. 24 g/m
max. tightening torque for M3 screws⁽³⁾	0.4 Nm (3.5 lbf in)

⁽¹⁾ for additional information please see LED mode page 6

⁽²⁾ with optional programming device and software

⁽³⁾ lbf in = poundforce inch

Resolution and Speed

Default Values at Output Frequency $F = 1000\text{ kHz}$

Pole Pitch P [mm]	Resolution R [μm]	Max. Movement Speed V_{max} [m/s]
0.5	0.25	1
1	0.5	2
2	1	4
2.54	1.27	5.08
5	2.5	10

Sensing Head Variants

Pole pitch	0.5 mm; 1 mm; 2 mm; 2.54mm; 5 mm
Reference	Reference chip for 2nd track (except for 0.5 mm pole pitch) or periodically from the pole pitch
Supply voltage	5 V \pm 5 % 7 - 36 V
Interface (without load)	RS422 (0 to 5 V) Push-Pull TTL (0 - 5 V)
Cable length of sensing head	0.1 - 6 m standard: 2 m
Connector	D-SUB 9 (male) D-SUB 15 (male) D-SUB 25 (female) D-SUB 15 HD (male) Customer specific connector

Output Circuit

RS422

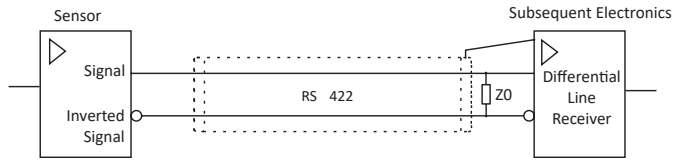

load resistor $Z_0 = 120 \Omega$ at receiving end

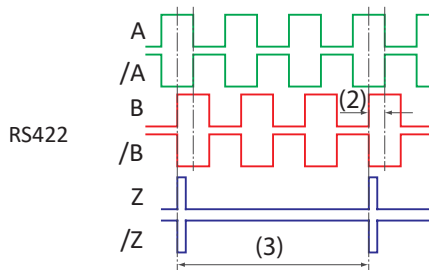

Push-Pull (TTL)

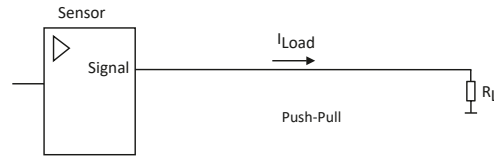

maximum of 50 mA per channel at a supply voltage of 5 V

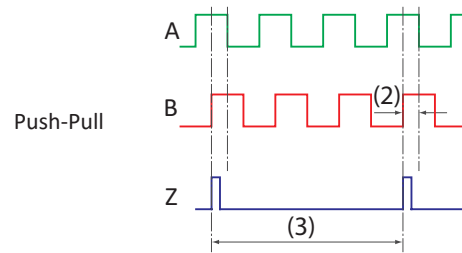

⁽²⁾ phase shift A and B $90^\circ \pm 10^\circ$ electrical

⁽³⁾ signal period depending on the reference track pattern or as a periodic reference depending on pole pitch

Z: length default is 50 counts

Output Signals

signals	A, /A, B, /B, Z, /Z
signal error indicator	high impedance on all output signals (A, /A, B, /B, Z, /Z)

To avoid EMI please connect housing or threaded bushing to protective earthing!

Further Selection (Ordering Parameters)

pole pitch P [mm]					resolution R [μm]	resolution Rdpi [dpi]	maximum output frequency per channel F [kHz]					
0.5	1	2	2.54	5			3500	1750	1000	500	100	60
			(0.1 in)				max. movement speed V_{max} [m/s]					
				x	1250	20.32	>100	>100	>100	>100	>100	>100
		x		x	500	50.8	>100	>100	>100	>100	>100	>100
	x	x		x	200	127	>100	>100	>100	>100	80	48
x	x	x		x	100	254	>100	>100	>100	>100	40	24
		x			80	317.5	>100	>100	>100	>100	32	19.2
x	x	x		x	62.5	406.4	>100	>100	>100	>100	25	15
x	x	x		x	50	508	>100	>100	>100	>100	20	12
	x	x		x	40	635	>100	>100	>100	80	16	9.6
x	x	x		x	25	1016	>100	>100	>100	50	10	6
x	x	x	x	x	20	1270	>100	>100	80	40	8	4.8
x	x	x		x	12.5	2032	>100	87.5	50	25	5	3
x	x	x	x	x	10	2540	>100	70	40	20	4	2.4
x	x	x	x	x	5	5080	70	35	20	10	2	1.2
x	x	x	x	x	4	6350	56	28	16	8	1.6	0.96
x	x	x	x	x	2.5	10160	35	17.5	10	5	1	0.6
x	x	x	x	x	2	12700	28	14	8	4	0.8	0.48
x	x	x	x	x	1	25400	14	7	4	2	0.4	0.24
x	x	x	x	x	0.5	50800	7	3.5	2	1	0.2	0.12
x	x	x	x	x	0.25	101600	3.5	1.75	1	0.5	0.1	0.06
x	x	x	x	x	0.125	203200	1.75	0.875	0.5	0.25	0.05	0.03
x	x	x	x		0.05	508000	0.7	0.35	0.2	0.1	0.02	0.012
x	x				0.02	1270000	0.28	0.14	0.08	0.04	0.008	0.0048

table 1: maximum output frequency and speed as a function of pole pitch and resolution

Definition

pole pitch P	available 0.5; 1; 2; 2.54 and 5 mm
resolution R	$R = P / R_f$ resolution is after four-edge analyses
resolution Rdpi [dpi]	$Rdpi = 25400 / R$
resolution factor Rf	resolution factor available from 4 to 65536 in steps of one
maximum output frequency per channel F	available from 60 kHz to 3500 kHz
max. movement speed V_{max}	V_{max} is limited by following conditions: 1. $V_{max} = 4 * F * R$ 2. $V_{max} = P * 50 \text{ kHz}$
interpolation	$= R_f / 4$

LED Error Codes (Order Parameter E1)

The amount of flashing signs of the red LED indicates the fault. It starts after a fast pulsed light.

The example displays a weak and fluctuating magnetic field (fault 2 and 3).

LED flashing signs amount	description
1	magnetic field strength is too high
2	magnetic field strength is too low
3	the range of the magnetic fluctuation is too large
4	output frequency is too high
5	movement speed is too high
6	movement speed is much too high (latched)
7, 8	movement speed too high for internal signal processing with current programming (latched)
9, 10, 11	internal error 9, 10, 11 (latched)

Dimensions

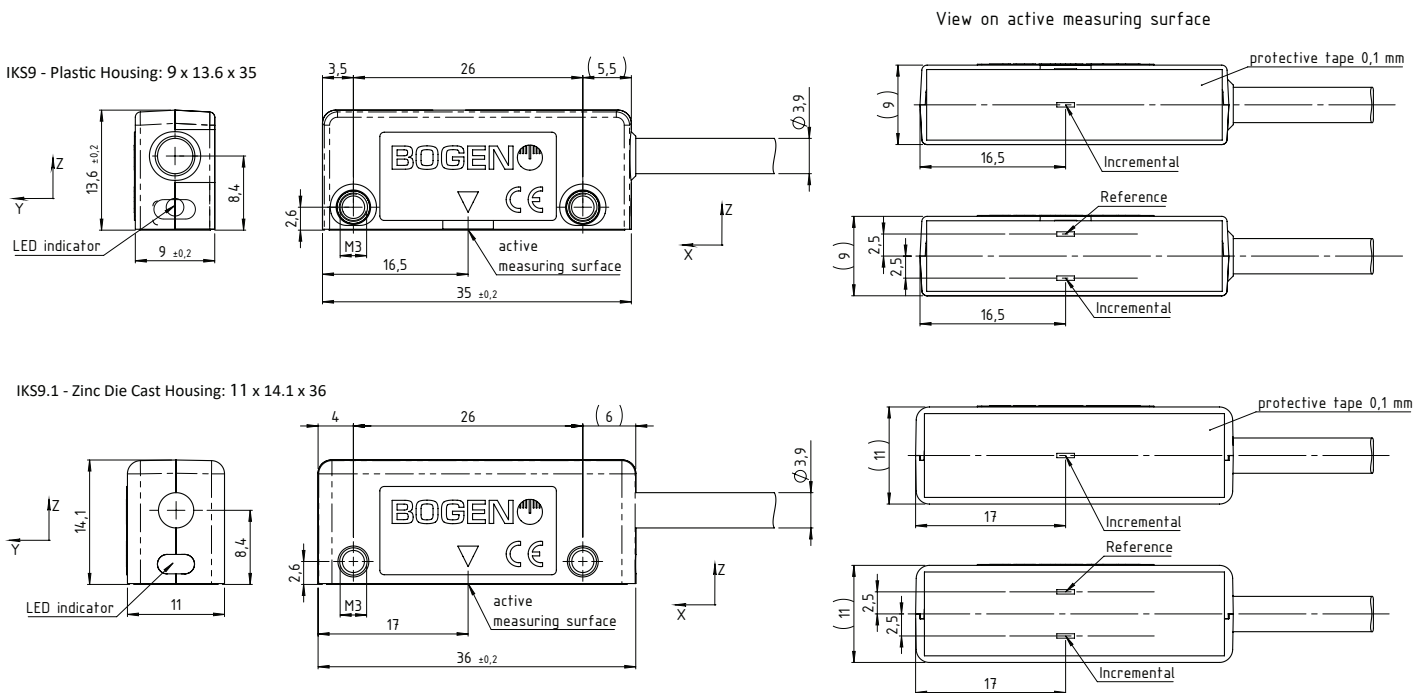

dimensions without tolerances: ± 0.1 mm; forward movement: in positive direction of X-axis; backward movement: in negative direction of X-axis.

Installation Tolerances for Linear Applications

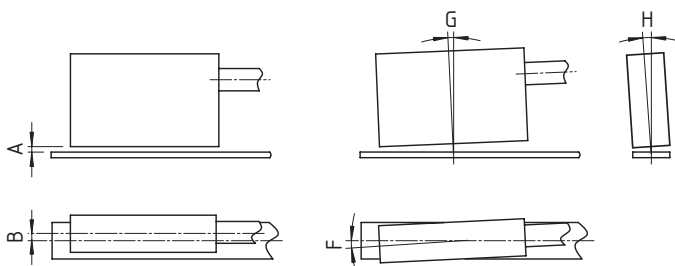

	pole pitch				
	0.5 mm	1 mm	2 mm	2.54 mm	5 mm
A [mm]	0.1 to 0.25	0.1 to 0.5	0.1 to 1.0	0.1 to 1.25	0.1 to 2.5
B ^[4] [mm]	2.5	2.5	2.5	2.5	2.5
B ^[5] [mm]	0.5	0.5	0.5	0.5	0.5
G	0.5°	1°	1°	1°	1°
H	3°	3°	3°	3°	3°
F	3°	3°	3°	3°	3°

^[4] relative to 10 mm scale width (1-track)

^[5] relative to 10 mm scale width (2-track)

Pin Assignment

signal	colour	C3 D-SUB 9 (male)	C4 D-SUB 15 (male)	C5 D-SUB 25 (female)	C6 D-SUB 15 HD (male)
V -	blue	9	2	2 + 16 (6)	2
V +	red	5	7	1 + 14 (6)	7
A	brown	4	14	3	14
/A	green	8	6	4	6
B	grey	3	13	6	13
/B	yellow	7	5	7	5
Z	pink	2	12	17	12
/Z	white	6	4	18	4
shield	-	case	case	case	case + 15

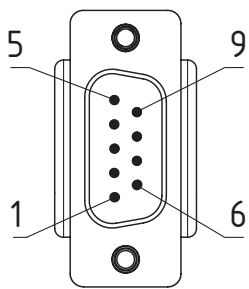

C3: D-SUB 9 (male)

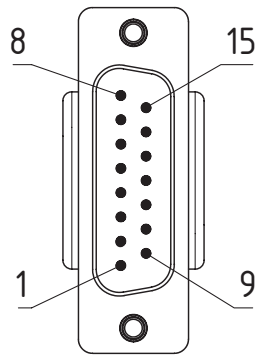

C4: D-SUB 15 (male)

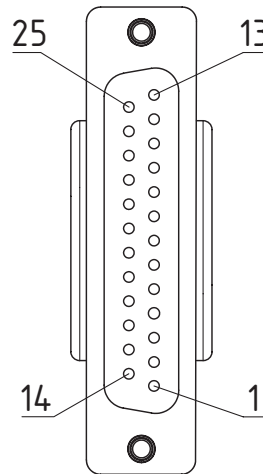

C5: D-SUB 25 (female)

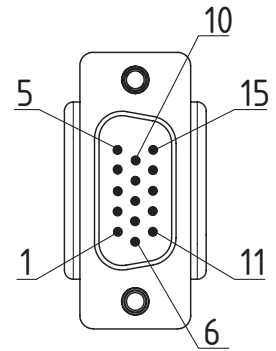

C6: D-SUB 15 HD (male)

For detailed technical features on optional accessories such as rotary and linear scales please see separate data sheets.

Optional Accessory

- programming unit for IKS9 [00053024]
- linear and rotary scales (for detailed information see separate data sheets)
 - » LMS: Linear magnetic scale from few mm to many meters
 - » LMSBI: Linear magnetic scale bar incremental for high accuracy applications
 - » RMSI: Rotary magnetic scale incremental in diameters from 10 mm to 1 m
 - » Recommended width without reference track: 5 mm, 6 mm, 8 mm, 10 mm
 - » Recommended width with reference track: 8 mm, 10 mm
 - » Available accuracy classes: A3, A10, A20, A40, A100
- available pole pitches: 0.5 mm, 1 mm, 2 mm, 2.54 mm, 5 mm

Order Code

IKS9 W - Z P V D R F T L C E

		Code ⁽⁸⁾	Explanation ⁽⁸⁾	
W	width [mm]		9 mm (Plastic case)	
		.1	11 mm (Metal case)	
Z	reference signal (9,10)	Z1.50	periodic reference signal from the pole pitch, length of reference signal 50 counts	
		Z1. ...	periodic reference signal from the pole pitch, length of reference signal ... counts ⁽¹¹⁾	
		Z2. ...	from reference marks (requires 2-track magnetic tape with incremental track and reference track), length of reference signal ... counts ⁽¹¹⁾	
P	pole pitch [mm]	P0.5	0.5 mm (not interoperable with Z2)	
		P1	1 mm	
		P2	2 mm	
		P2.54	2.54 mm	
		P5	5 mm	
V	supply voltage [V]	V5	5 V	
D	interface (9)	D1	RS422	
		D3	Push-Pull TTL	
R	resolution (9, *)	R0.25	0.25 µm (Standard for pole pitch 0.5 mm)	
		R0.5	standard for pole pitch 1 mm	
		R1	standard for pole pitch 2 mm	
		R#...	...dpi (Standard for pole pitch 2.54 mm)	
		R2.5	standard for pole pitch 5 mm	
		R...	other non-standard resolutions, see section "Resolution and Speed" in table 1 on page 2	
F	maximum output frequency per channel (9) [kHz]	F1000	1000 kHz	
		F ...	other non-standard output frequencies, see section "Resolution and Speed" in table 1 on page 2	
T	cable type	T2	drag chain quality (4 mm diameter)	
		T99	customer specific cable	
L	cable length [m]	L1	1 m	
		L3	3 m	
		L m (maximum cable length: 6 m)	
C	connector (others on request)	C3	D-SUB 9 (male)	
		C4	D-SUB 15 (male)	
		C5	D-SUB 25 (female)	
		C6	D-SUB 15 HD (male)	
		C99	customer specific connector	
E	LED Mode (9)	E0	LED Green: Low -> sufficient magnetic field Bright -> best performance	
			LED RED: Error signalization with LED on	
E1	E1	LED Green: Low -> sufficient magnetic field Bright -> best performance	Error signalization with blinking codes, see on page 3	
				LED RED:

⁽⁸⁾ standard parameters are bold

⁽⁹⁾ user programmable parameters (optional IKS-Programming device necessary)

⁽¹⁰⁾ if no index signal is needed, please do not connect pin "Z" an "/Z" on delivered connector

⁽¹¹⁾ length of index signal available from 1 to 256

^(*) R... for metric based pole pitches / R#... for inch based pole pitches

Ordering Example

IKS9-Z1.50P2V5D1R1F1000T2L2C4E1	<p>IKS9 Magnetic Sensing Head, width 9 mm, with periodic reference signal, reference length 50 counts, 2 mm pole pitch, voltage 5 V, interface RS422, 1 µm resolution, max. output frequency 1000 kHz, Drag chain quality (4 mm diameter), cable length 2 m, D-SUB 15 (male) connector, error signalization with blinking error codes</p>
IKS9.1-Z2.1P5V24D3R125F100T2L5.5C5E0	<p>IKS9 Magnetic Sensing Head, width 11 mm, with reference signal from reference marks (2-track magnetic tape), reference length 1 count, 5 mm pole pitch, voltage 7 - 32 V (broad-range), interface Push-Pull TTL, 125 µm resolution, max. output frequency 100 kHz, Drag chain quality (4 mm diameter), cable length 5.5 m, D-SUB 25 (female) connector, error signalization with LED RED on</p>

BOGEN can provide customised resolutions and cables. This is an example for a customized order code:

IKS9.1-Z2.50P2V5D1R0.244140625F3500T99L0.3C4E1	<p>IKS9 Magnetic Sensing Head, width 11 mm, with reference signal from reference marks (2-track magnetic tape), reference length 50 count, 2 mm pole pitch, voltage 5 V, interface RS422, 0.244140625 µm resolution, max. output frequency 3500 kHz, customer specific cable length 0.3 m, D-SUB 15 (male) connector, error signalization with blinking error codes</p>
--	---

Corresponding Linear and Rotary Magnetic Scales

BOGEN offers a comprehensive scope of standard and tailor-made scales in a variety of sizes and accuracy classes.

For more information on our standard linear and rotary magnetic scales, [please refer to our dedicated datasheets](#).

For your special requests, [please click here to contact our application engineers](#).



BOGEN Magnetics GmbH reserves the right to make changes, without notice, in the products, including software, described or contained herein in order to improve design and/or performance. Information in this document is believed to be accurate and reliable. However, BOGEN Magnetics GmbH does not give any representations or warranties, expressed or implied, as to the accuracy or completeness of such information and shall have no liability for the consequences of use of such information. BOGEN Magnetics GmbH takes no responsibility for the content in this document if provided by an information source outside of BOGEN products. In no event shall BOGEN Magnetics GmbH be liable for any indirect, incidental, punitive, special or consequential damages (including but not limited to lost profits, lost savings, business interruption, costs related to the removal or replacement of any products or rework charges) irrespective the legal base the claims are based on, including but not limited to tort (including negligence), warranty, breach of contract, equity or any other legal theory. Notwithstanding any damages that customer might incur for any reason whatsoever, BOGEN product aggregate and cumulative liability towards customer for the products described herein shall be limited in accordance with the General Terms and Conditions of Sale of BOGEN Magnetics GmbH. Nothing in this document may be interpreted or construed as an offer to sell products that is open for acceptance or the grant, conveyance or implication of any license under any copyrights, patents or other industrial or intellectual property rights. Unless otherwise agreed upon in an individual agreement BOGEN products sold are subject to the General Terms and Conditions of Sales as published at www.bogen-magnetics.com.